

Schnellverschraubungen Typ 300 und Typ 400

Push-on fittings Type 300 and 400



Features

- ▶ **Messingverschraubungen**
 - ▶ **Korrosionsschutz durch Vernickelung**
 - ▶ **für verschiedenste Anwendungsmöglichkeiten**
 - ▶ **drehbare Verschraubungen, Schwenkverschraubungen**
 - ▶ **teilweise O-Ring-Abdichtung**
 - ▶ **für Schlauchdurchmesser von 4 bis 12mm**
- ▶ **Brass fittings**
 - ▶ **Nickel-plated for corrosion protection**
 - ▶ **For various applications**
 - ▶ **Rotating fittings, tilting fittings**
 - ▶ **O-ring seal in parts**
 - ▶ **For tube diameters from 4 mm to 12 mm**

Technische Daten Technical data

Betriebstemperatur	bis +80°C	abhängig von den Temperatureigenschaften des Schlauches
Betriebsdruck	bis 20bar	abhängig vom Druckbereich des eingesetzten Schlauches
Werkstoffe	Körper und Überwurfmutter Messing (Ms58) vernickelt O-Ringe aus NBR Dichtungen aus PVC	
Gewinde	zyl. Gew. DIN EN ISO 228 kon. Gew. DIN EN 10226 (DIN 2999) metr. Gew. DIN ISO 262	zylindrisch mit O-Ring-Abdichtung
Medium	pneumatische, ölhdraulische und hydraulische Kreisläufe	
Schläuche	geeignet für diverse Kunststoffschläuche	auch für PVU synthesefadenarmiert

Operating temperature	Up to +80°C	Dependent on the tube's temperature characteristics
Operating pressure	Up to 20 bar	Dependent on the pressure range of the tube used
Materials	Body and swivel nut, brass (Ms58), nickel-plated NBR O-rings PVC seals	
Thread	Cyl. thread, DIN EN ISO 228 Con. thread, DIN EN 10226 (DIN 2999) Metr. Thread, DIN ISO 262	Cylindrical with O-ring seal
Medium	Pneumatic, oil-hydraulic and hydraulic circuits	
Tubes	Suitable for various plastic tubes	Also for reinforced PVU synthetic fibres

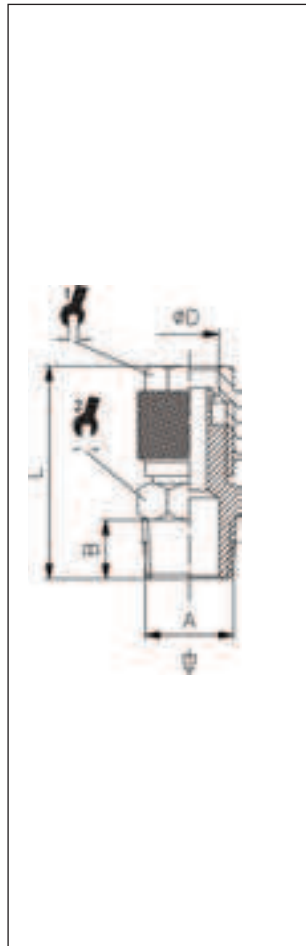

301

gerade Einschraubverschraubung konisch

Taper straight male adaptor

ITV	ØD	A	B	L			
10003	4/2,7	R ¹ / ₈	7,5	23	8	12	100
10004	5/3	R ¹ / ₈	7,5	23	8	12	100
10005	6/4	R ¹ / ₈	7,5	25,5	10	12	100
10006	6/4	R ¹ / ₄	11	27	10	14	100
10007	8/6	R ¹ / ₈	7,5	27	12	14	100
10008	8/6	R ¹ / ₄	11	31	12	14	100
10009	8/6	R ³ / ₈	11,5	31,5	12	17	100
10010	8/6	R ¹ / ₂	14	34	12	22	100
10011	10/8	R ¹ / ₈	7,5	29	14	14	100
10012	10/8	R ¹ / ₄	11	33	14	14	100
10013	10/8	R ³ / ₈	11,5	33,5	14	17	100
10014	10/8	R ¹ / ₂	14	36,5	14	22	50
10015	12/10	R ³ / ₈	11,5	35	15	17	50
10016	12/10	R ¹ / ₂	14	38	15	22	50
10017	15/12,5	R ¹ / ₂	14	40	22	22	50

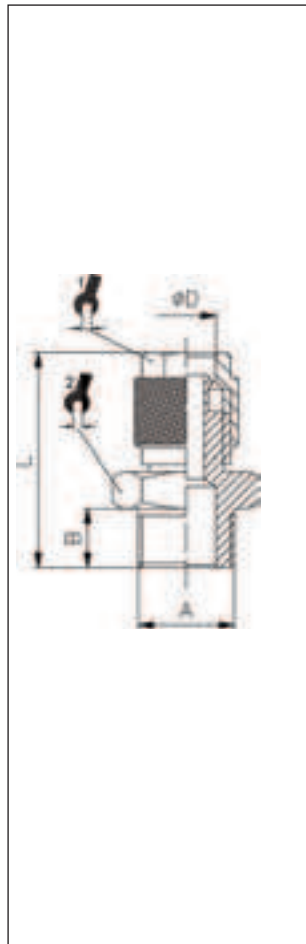

301/Z

gerade Einschraubverschraubung zylindrisch

Straight male adaptor, cyl.

*mit O-Ring *with O-ring

ITV	ØD	A	B	L			
10202	4/2,7	M5	4	19,5	7	8	100 *
10224	4/2,7	G ¹ / ₈	6	25	7	13	100 *
10203	4,3/3	M5	4	19,5	8	8	100
10204	4,3/3	G ¹ / ₈	6	25	8	13	100 *
10205	5/3	M5	4	22	8	8	100
10207	5/3	G ¹ / ₈	6	25	8	13	100 *
10208	6/4	M5	4	22	8	9	100
10209	6/4	G ¹ / ₈	6	25	10	13	100
10210	6/4	G ¹ / ₄	8	27	10	17	100
10211	6/4	G ³ / ₈	9	27,5	10	19	100 *
10225	6/4	G ¹ / ₂	10	30	10	24	100 *
10212	8/6	G ¹ / ₈	6	25	12	14	100
10213	8/6	G ¹ / ₄	8	27	12	17	100
10214	8/6	G ³ / ₈	9	30	12	19	100
10215	8/6	G ¹ / ₂	10	30	12	24	100 *
10226	10/8	G ¹ / ₈	6	27,5	14	14	50
10216	10/8	G ¹ / ₄	8	30	14	17	50
10217	10/8	G ³ / ₈	9	31	14	19	50
10218	10/8	G ¹ / ₂	10	32,5	14	24	50 *
10219	12/10	G ³ / ₈	9	32,5	15	19	50 *
10220	12/10	G ¹ / ₂	10	34	15	24	50 *
10221	15/12,5	G ¹ / ₂	10	34	22	24	50 *
10222	12/9	G ¹ / ₄	8	31	15	17	50
10223	12/9	G ³ / ₈	9	31	15	20	50

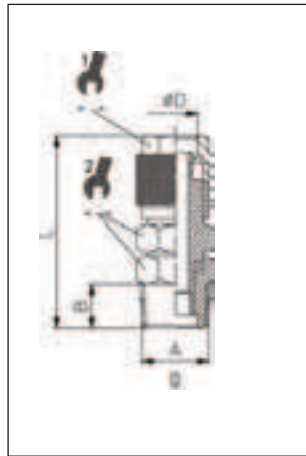

301DK

gerade Einschraubverschraubung drehbar konisch

Swivel straight taper adaptor

ITV	ØD	A	B	L				
10101	6/4	R ¹ / ₈	7,5	32,5	10	12	100	
10102	6/4	R ¹ / ₄	11,0	36,5	10	14	100	
10103	8/6	R ¹ / ₈	7,5	32,5	12	12	100	
10104	8/6	R ¹ / ₄	11,0	36,5	12	14	100	
10105	10/8	R ¹ / ₄	11,0	37,5	14	14	50	
10106	12/10	R ³ / ₈	11,5	39,5	15	17	50	

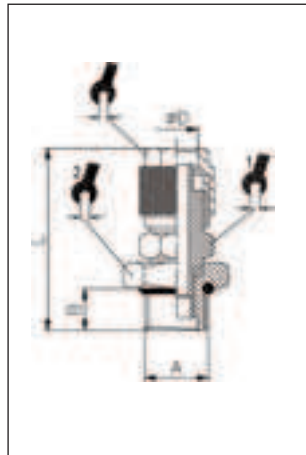

301DZ

gerade Einschraubverschraubung drehbar zylindrisch mit O-Ring

Swivel straight parallel adaptor with O-Ring

ITV	ØD	A	B	L				
10151	6/4	G ¹ / ₈	6	31	10	12	14	100
10152	6/4	G ¹ / ₄	8	33,5	10	14	17	100
10154	8/6	G ¹ / ₈	6	31	12	12	14	100
10155	8/6	G ¹ / ₄	8	33,5	12	14	17	100
10156	10/8	G ¹ / ₄	8	34,5	14	14	17	50
10157	12/10	G ³ / ₈	9	37	15	17	19	50

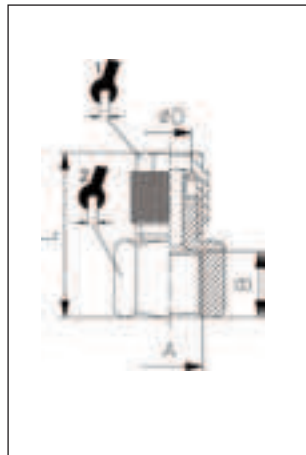

302

Manometerverschraubung | Straight female adaptor

ITV	ØD	A	B	L				
10302	6/4	G ¹ / ₈	7,5	23,5	10	14	100	
10303	6/4	G ¹ / ₄	11	27	10	17	100	
10304	6/4	G ³ / ₈	11,5	28	10	22	100	
10314	6/4	G ¹ / ₂	11	26,5	10	24	100	
10305	8/6	G ¹ / ₈	7,5	24,5	12	14	100	
10306	8/6	G ¹ / ₄	11	28,5	12	17	100	
10307	8/6	G ³ / ₈	11,5	29	12	22	100	
10308	8/6	G ¹ / ₂	15	33	12	24	100	
10310	10/8	G ¹ / ₄	11	30,5	14	17	100	
10311	10/8	G ³ / ₈	11,5	33,5	14	22	50	
10312	10/8	G ¹ / ₂	15	34,5	14	24	50	
10313	12/10	G ³ / ₈	11,5	31	15	22	50	

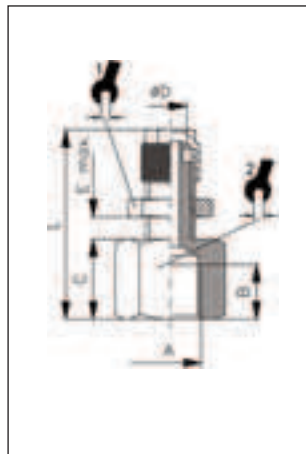

302F

Manometer-Schottverschraubung

Straight female adaptor (special)

ITV	ØD	A	B	C	E	L			
10520	5/3	M5	4,5	8	8	29	8	9	100
10521	6/4	G ¹ / ₈	8,0	12	10	38	10	13	100
10522	8/6	G ¹ / ₈	12,0	12	10	39	12	17	100
10523	8/6	G ¹ / ₄	12,0	18	10	45	12	17	100
10524	12/9	G ¹ / ₄	12,0	18	10	47	15	22	50
10525	8/6	G ³ / ₈	12,0	19	10	46	12	17	50
10526	12/9	G ³ / ₈	12,0	19	10	51	15	22	25

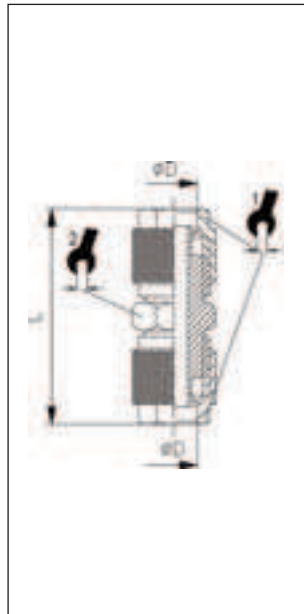

303

gerader Verbinder

Straight connector

ITV	ØD	L			
10403	4/2,7	27,5	7	8	100
10404	5/3	31,5	8	10	100
10405	6/4x5/3	32	10	12	100
10406	6/4	32	10	12	100
10407	8/6x6/4	35,5	12	12	100
10408	8/6	35	12	12	100
10409	10/8x6/4	35,5	14	14	100
10410	10/8x8/6	37	14	14	100
10411	10/8	39	14	14	100
10412	12/10	43	15	17	50
10413	15/12,5	47	22	22	50

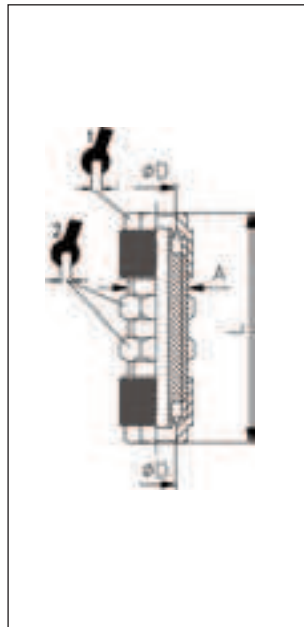

304

gerader Schottverbinder

Bulkhead union

ITV	ØD	A	L			
10501	4/2,7	M6x0,5	39,5	7	9	100
10502	5/3	M7x0,75	39,5	8	9	100
10503	6/4x5/3	M10x1	45,5	10	14	100
10504	6/4	M10x1	45	10	14	100
10505	8/6x6/4	M12x1	47,5	12	17	100
10506	8/6	M12x1	48,5	12	17	100
10507	10/8x6/4	M14x1	50	14	17	100
10508	10/8x8/6	M14x1	51	14	17	100
10509	10/8	M14x1	54	14	17	100
10510	12/10	M16x1	57	15	19	50
10511	15/12,5	M20x1	59	22	24	50
10512	12/9	M16x1	58	15	19	50

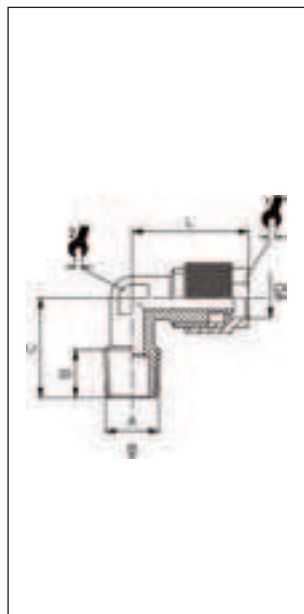

305

Winkeleinschraubverschraubungen konisch

Elbow male adaptor, con.

ITV	ØD	A	B	C	L			
11001	5/3	R ¹ / ₈	7,5	15	18,5	8	8	100
11003	6/4	R ¹ / ₈	8,5	17	21	10	8	100
11004	6/4	R ¹ / ₄	11	19	20,5	10	8	100
11006	8/6	R ¹ / ₈	8,5	17	20	12	9	100
11007	8/6	R ¹ / ₄	11	19	22	12	9	100
11008	8/6	R ³ / ₈	11	21	21	12	9	100
11009	8/6	R ¹ / ₂	14	28	23,5	12	16	50
11010	10/8	R ¹ / ₈	7,5	18	24	14	11	100
11011	10/8	R ¹ / ₄	11	22	24	14	11	100
11012	10/8	R ³ / ₈	11,5	22	25,5	14	11	50
11013	10/8	R ¹ / ₂	14	28	23,5	14	16	50
11014	12/10	R ³ / ₈	11,5	22,5	27	15	13	50
11015	12/10	R ¹ / ₂	14	28	27	15	16	50
11016	15/12,5	R ¹ / ₂	14	28	31,5	22	16	50

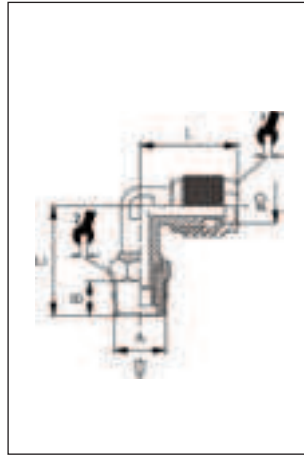

305DK

Winkeleinschraubverschraubungen konisch

Swivel elbow male adaptor, con.

ITV	ØD	A	B	C	L			
11101	6/4	R ¹ / ₈	7,5	21,5	20,5	10	12	100
11102	6/4	R ¹ / ₄	11	25	20,5	10	14	100
11103	8/6	R ¹ / ₈	7,5	21,5	21,5	12	12	100
11104	8/6	R ¹ / ₄	11	26	23	12	14	100
11105	10/8	R ¹ / ₄	11	27	24	14	14	100

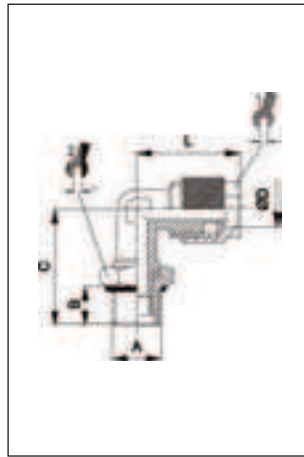

305DZ

Winkeleinschraubverschraubungen zyl. mit O-Ring

Swivel elbow adaptor with O-ring, cyl.

ITV	ØD	A	B	C	L			
11151	6/4	G ¹ / ₈	6	22	20,5	10	13	100
11152	6/4	G ¹ / ₄	8	26	20,5	10	16	100
11153	8/6	G ¹ / ₈	6	22	21,5	12	13	100
11154	8/6	G ¹ / ₄	8	26,5	23	12	16	100
11155	10/8	G ¹ / ₄	8	27,5	24	14	16	100

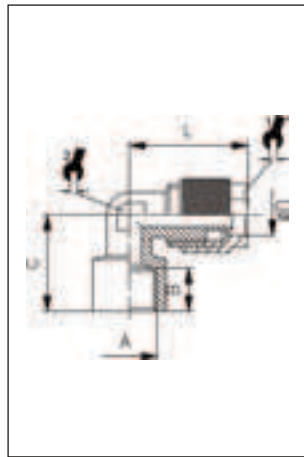

305F

Winkelaufschraubverschraubung

Straight female adaptor

ITV	ØD	A	B	C	L			
11201	5/3	G ¹ / ₈	7,5	18	20,5	8	8	100
11202	6/4	G ¹ / ₈	7,5	18	20,5	10	8	100
11203	6/4	G ¹ / ₄	11	21	21	10	9	100
11204	8/6	G ¹ / ₈	7,5	19	22	12	9	100
11205	8/6	G ¹ / ₄	11	21	23,5	12	9	100
11206	10/8	G ¹ / ₄	11	22	25,5	14	11	100
11207	10/8	G ³ / ₈	11,5	25	25,5	14	14	100

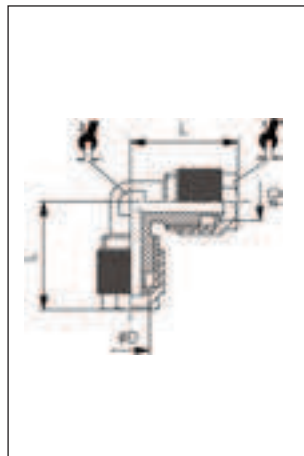

306

Winkelverbinder

Elbow connector

ITV	ØD	L			
11302	5/3	20,5	8	8	100
11303	6/4	20,5	10	8	100
11304	8/6x6/4	22	12	9	100
11305	8/6	22	12	9	100
11306	10/8	25,5	14	11	50
11307	12/10	27	15	13	50
11308	15/12,5	33,5	22	16	50

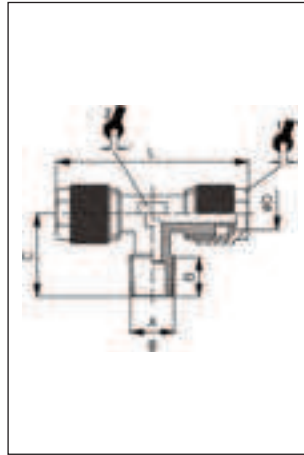

307

T-Einschraubverschraubung konisch | Central T-adapter, con.

ITV	ØD	A	B	C	L			
12002	5/3	R ¹ / ₈	7,5	15	37	8	8	100
12003	6/4	R ¹ / ₈	7,5	15	37	10	8	100
12004	6/4	R ¹ / ₄	11	19	41	10	9	100
12006	8/6	R ¹ / ₈	7,5	16,5	40	12	9	100
12007	8/6	R ¹ / ₄	11	20,5	44	12	9	100
12008	8/6	R ³ / ₈	11,5	20,5	45	12	12	100
12009	10/8	R ¹ / ₈	7,5	18	48	14	11	100
12010	10/8	R ¹ / ₄	11	22	48	14	11	50
12011	10/8	R ³ / ₈	11,5	22	51	14	11	50
12013	12/10	R ³ / ₈	11,5	22,5	54	15	13	50
12015	15/12,5	R ¹ / ₂	14	28	63	22	16	50

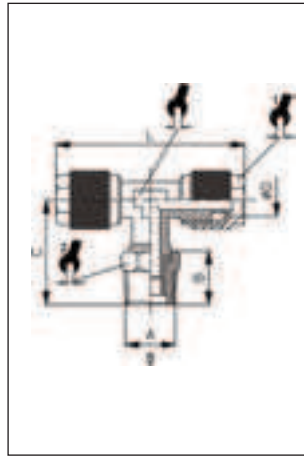

307DK

T-Einschraubverschraubung drehbar konisch

Central T-taper adaptor, con.

ITV	ØD	A	B	C	L				
12101	6/4	R ¹ / ₈	7,5	21,5	41	8	10	12	100
12102	6/4	R ¹ / ₄	11	25	41	9	10	14	100
12103	8/6	R ¹ / ₈	7,5	22	43	9	12	12	100
12104	8/6	R ¹ / ₄	11	25,5	43	9	12	14	100
12105	10/8	R ¹ / ₄	11	27	48	11	14	14	100

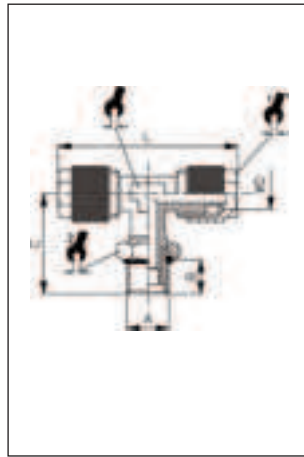

307DZ

T-Einschraubverschraubung drehbar zylindrisch mit O-Ring

Rotary T-adaptor with O-ring, cyl.

ITV	ØD	A	B	C	L				
12151	6/4	G ¹ / ₈	6	22	39	8	8	13	100
12152	6/4	G ¹ / ₄	8	26	39	9	8	16	100
12153	8/6	G ¹ / ₈	6	24	40	9	9	13	100
12154	8/6	G ¹ / ₄	8	27,5	40	9	9	16	100
12155	10/8	G ¹ / ₄	8	27,5	45	11	11	16	100

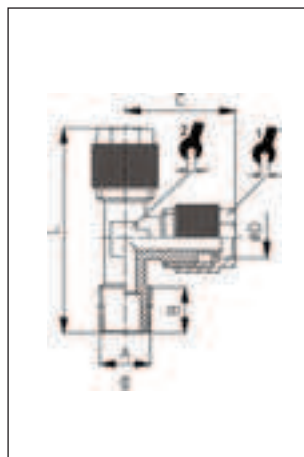

308

L-Einschraubverschraubung konisch | Off-set T-adaptor, con.

ITV	ØD	A	B	C	L			
12202	5/3	R ¹ / ₈	8,5	20,5	35,5	8	8	100
12203	6/4	R ¹ / ₈	8,5	20,5	35,5	10	8	100
12204	6/4	R ¹ / ₄	11	20,5	39	10	8	100
12205	8/6	R ¹ / ₈	8	22	36	12	9	100
12206	8/6	R ¹ / ₄	11	22	40	12	9	100
12207	8/6	R ³ / ₈	12	22	47	12	12	50
12208	10/8	R ¹ / ₈	7,5	25,5	38,5	14	11	50
12209	10/8	R ¹ / ₄	12	25,5	41	14	11	50
12210	10/8	R ³ / ₈	12	25,5	41,5	14	11	50
12212	12/10	R ³ / ₈	12,5	28	45	15	13	50
12214	15/12,5	R ¹ / ₂	14,5	32,5	54	22	16	25

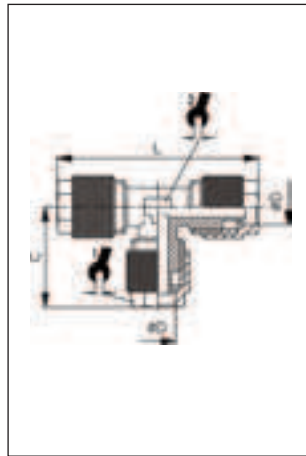

309
T-Verbinder
T-connector

ITV	ØD	C	L			
12300	4/2,7	19,5	38,5	7	8	100
12302	5/3	20,5	41	8	8	100
12303	6/4	20,5	41	10	8	100
12304	8/6x6/4	20,5	44	12	9	100
12305	8/6	22	44	12	9	100
12306	10/8x6/4	20,5	51	14	11	100
12307	10/8x8/6	22	51	14	11	50
12308	10/8	25,5	51	14	11	50
12309	12/10	28	54	15	13	50
12310	15/12,5	32,5	63	22	16	25

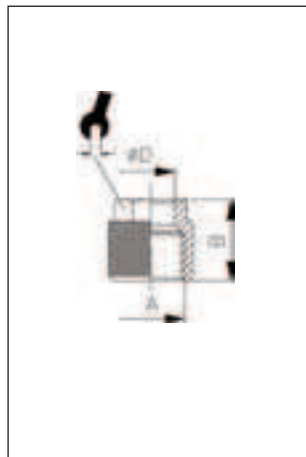
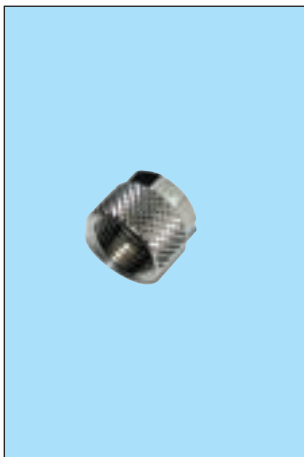

310
Überwurfmutter
Union nut

ITV	ØD	A	B		
17001	4/2,7	M6x0,5	10	7	100
17002	4,3/3	M7x0,75	10	8	100
17003	5/3	M7x0,75	10	8	100
17004	6/4	M8x0,75	11	8	100
17005	6/4	M10x1	11	10	100
17006	8/6	M12x1	11,5	12	100
17007	10/8	M14x1	13,5	14	100
17008	12/10	M16x1	15	15	100
17009	15/12,5	M20x1	16	22	50

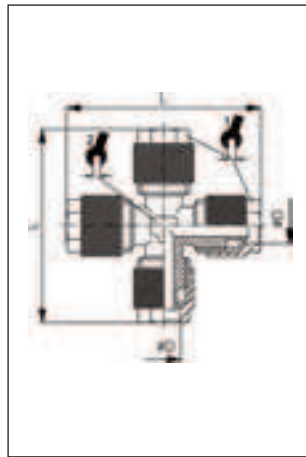

311
Kreuzverbinder
Cross adaptor

ITV	ØD	L			
13001	5/3	41,5	8	8	100
13002	6/4	41,5	10	8	100
13003	8/6	44,5	12	9	100
13004	10/8	51	14	11	50
13005	12/10	58	15	13	50
13006	15/12,5	64	22	17	50

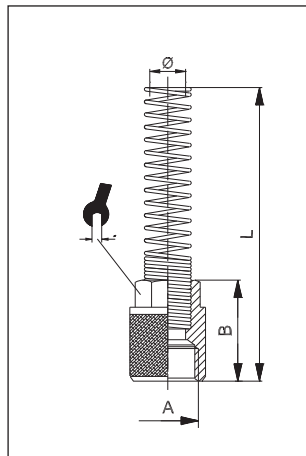

312
Knickschutzfeder mit Mutter
Nut + protective spring

ITV	ØD	A	B	L		
17101	6/4	M10x1	18	93	10	50
17102	8/6	M12x1	18	98	12	50
17103	10/8	M14x1	20	105	14	50
17104	12/10	M16x1	22	112	15	50

Typ 300 + 400

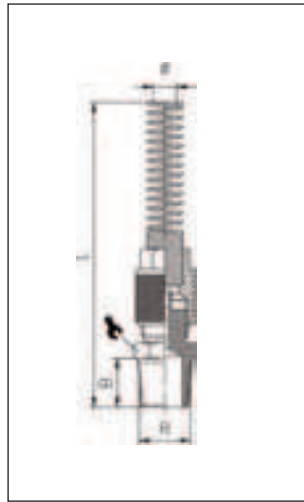

313

Einschraubverschraubung kon. mit Knickschutzfeder

Nut + spring

ITV	Ø	R	B	L		
10251	6/4	R ^{1/8}	7,5	107,5	12	50
10252	6/4	R ^{1/4}	11	111,5	14	50
10253	8/6	R ^{1/8}	7,5	113,5	14	50
10254	8/6	R ^{1/4}	11	117,5	14	50
10255	8/6	R ^{3/8}	11,5	118,5	17	50
10256	8/6	R ^{1/2}	14	120,5	22	50
10257	10/8	R ^{1/8}	7,5	120,5	14	50
10258	10/8	R ^{1/4}	11	124,5	14	50
10259	10/8	R ^{3/8}	11,5	125	17	25
10260	10/8	R ^{1/2}	14	128	22	25
10261	12/10	R ^{3/8}	11,5	132	17	25
10262	12/10	R ^{1/2}	14	135	22	25

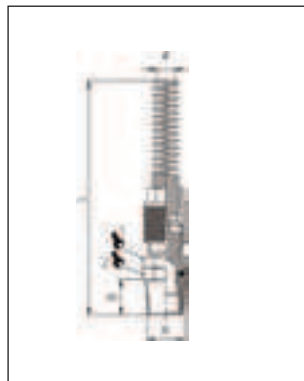

314

Einschraubverschraubung kon. mit Knickschutzfeder - drehbar

Swivel Nut + spring

ITV	Ø	R	B	L			
10263	6/4	R ^{1/8}	7,5	118	12	12	50
10264	6/4	R ^{1/4}	11	122	14	14	50
10265	8/6	R ^{1/8}	7,5	123	12	12	50
10266	8/6	R ^{1/4}	11	127	14	14	50
10267	10/8	R ^{1/4}	11	134	14	14	25
10268	12/10	R ^{3/8}	11,5	142	17	17	25

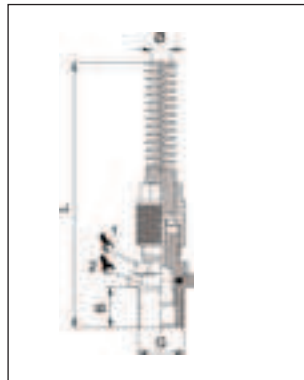

315

Einschraubverschraubung zyl. mit Knickschutzfeder - drehbar mit O-Ring

Swivel Nut + spring

ITV	Ø	G	B	L			
10271	6/4	G ^{1/8}	7,5	118	12	13	50
10272	6/4	G ^{1/4}	11	122	14	16	50
10273	8/6	G ^{1/8}	7,5	123	12	13	50
10274	8/6	G ^{1/4}	11	127	14	16	50
10275	10/8	G ^{1/4}	11	134	14	16	25
10276	12/10	G ^{3/8}	11,5	142	17	18	25

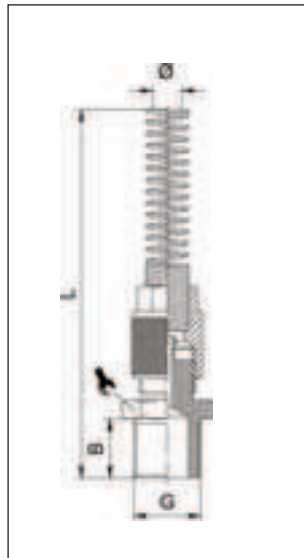

316

Einschraubverschraubung zyl. mit Knickschutzfeder

*mit O-Ring | Nut + spring

ITV	Ø	G	B	L		
10281	6/4	G ^{1/8}	6	106	13	50
10282	6/4	G ^{1/4}	8	108,5	17	50
10283	6/4	G ^{3/8}	9	109,5	19	50 *
10284	6/4	G ^{1/2}	10	112	24	50 *
10285	8/6	G ^{1/8}	6	112	14	50
10286	8/6	G ^{1/4}	8	114,5	17	50
10287	8/6	G ^{3/8}	9	115,5	19	50
10288	8/6	G ^{1/2}	10	116,5	24	50
10289	10/8	G ^{1/8}	6	119	14	50
10291	10/8	G ^{1/4}	8	121	17	50
10292	10/8	G ^{3/8}	9	122,5	19	25
10293	10/8	G ^{1/2}	10	124	24	25 *
10294	12/10	G ^{3/8}	9	129,5	19	25 *
10295	12/10	G ^{1/2}	10	131	24	25 *

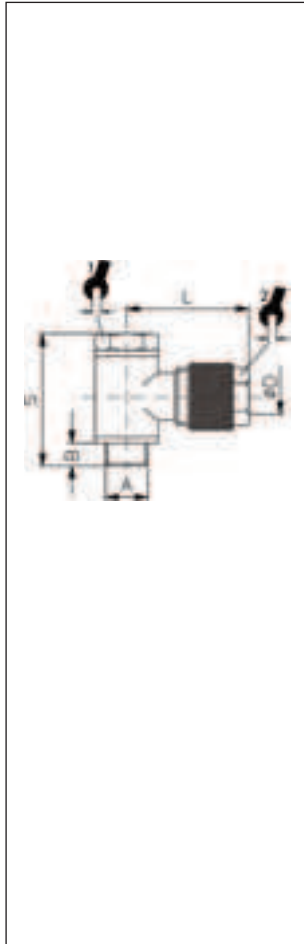

401

Winkelschwenkverschraubung

Complete single banjo adaptor

ITV	ØD	A	B	S	L			
S25521	4/2,7	M5	3,5	23	16,5	7	8	100
S25523	4/2,7	G ¹ / ₈	6	28	23	7	10	100
S25500	4,3/3	M5	4	17,5	16,5	8	8	100
S25518	4,3/3	G ¹ / ₈	6	28	21	14	8	100
S25519	5/3	M5	4	17,5	16,5	8	8	100
S25520	5/3	G ¹ / ₈	4	28	23	14	8	100
S25501	6/4	M5	4	17,5	16,5	8	9	100
S25502	6/4	G ¹ / ₈	5,5	28	23	14	10	100
S25503	6/4	G ¹ / ₄	8	33	26	17	10	100
S25504	6/4	G ³ / ₈	9	36	26	19	10	100
S25505	8/6	G ¹ / ₈	5,5	28	23	14	12	100
S25506	8/6	G ¹ / ₄	8	33	26	17	12	100
S25507	8/6	G ³ / ₈	9	36	26	19	12	100
S25508	8/6	G ¹ / ₂	10	42	31	24	12	100
S25530	10/8	G ¹ / ₈	6	28	27,5	14	14	50
S25509	10/8	G ¹ / ₄	8	33	29,5	17	14	50
S25510	10/8	G ³ / ₈	9	36	30,5	19	14	50
S25511	10/8	G ¹ / ₂	10	42	34	24	14	50
S25531	12/10	G ³ / ₈	9	36	31,5	19	15	25
S25512	12/10	G ¹ / ₂	10	42	35	24	15	25
S25513	12/9	G ¹ / ₄	10	36	26	17	15	25
S25514	12/9	G ³ / ₈	8	36	30	19	15	25
S25532	15/12,5	G ¹ / ₂	10	42	36,5	24	22	25

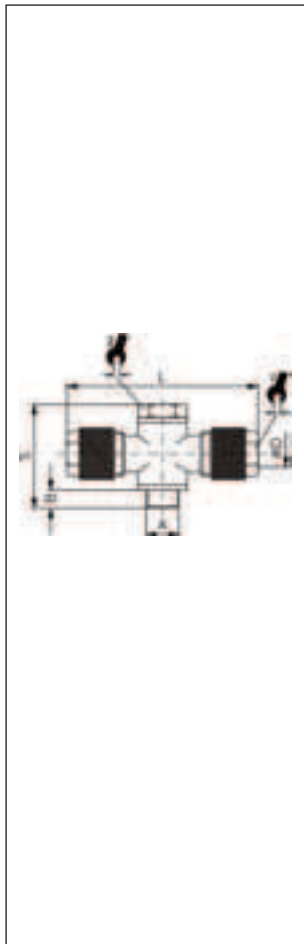

402

T-Schwenkverschraubung

Complete double banjo adaptor

ITV	ØD	A	B	S	L			
S25621	4,3/3	M5	4	17,5	33	8	8	100
S25622	4,3/3	G ¹ / ₈	6	28	46,5	8	14	100
S25623	5/3	M5	4	17,5	33	8	8	100
S25624	5/3	G ¹ / ₈	4	28	46,5	8	14	100
S25625	6/4	M5	4	17,5	33	9	8	100
S25601	6/4	G ¹ / ₈	6	28	46,5	10	14	100
S25602	6/4	G ¹ / ₄	8	33	50	10	17	100
S25603	6/4	G ³ / ₈	9,5	36	53,5	10	19	100
S25604	8/6	G ¹ / ₈	6	28	50	12	14	100
S25605	8/6	G ¹ / ₄	8	33	55	12	17	100
S25606	8/6	G ³ / ₈	9,5	36	55,5	12	19	100
S25607	8/6	G ¹ / ₂	10	42	61	12	24	100
S25631	10/8	G ¹ / ₈	6	28	53	14	14	50
S25608	10/8	G ¹ / ₄	8	33	59	14	17	50
S25609	10/8	G ³ / ₈	9	36	61	14	19	50
S25610	10/8	G ¹ / ₂	10	42	68	14	24	25
S25632	12/10	G ³ / ₈	9,5	36	63	15	19	25
S25611	12/10	G ¹ / ₂	10	42	70	15	24	25
S25614	12/9	G ³ / ₈	8	31,5	66	15	19	25
S25633	15/12,5	G ¹ / ₂	10	42	62	22	24	25

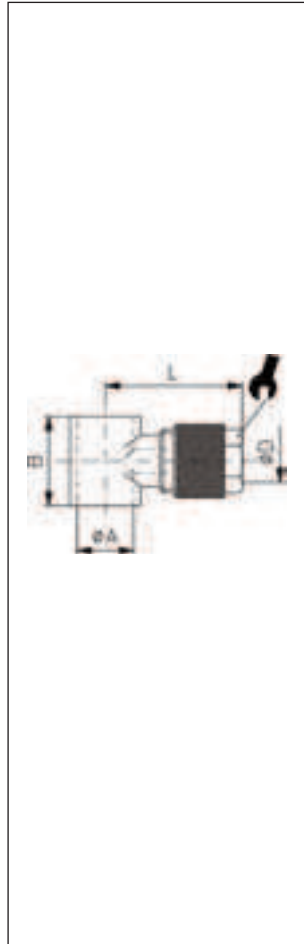

405

Ringstück 1-fach

Single banjo body

ITV	ØD	A	B	L		
15002	4/2,7	M5	9	16	8	100
15001	4/2,7	G ^{1/8}	15	21	8	100
15004	5/3	M5	9	15,5	8	100
15005	5/3	G ^{1/8}	15	23	8	100
15006	6/4	M5	9	16,5	9	100
15007	6/4	G ^{1/8}	15	23	10	100
15008	6/4	G ^{1/4}	17	26	10	100
15009	6/4	G ^{3/8}	20	26	10	100
15010	8/6	G ^{1/8}	15	23	12	100
15011	8/6	G ^{1/4}	17	26	12	100
15012	8/6	G ^{3/8}	20	26	12	100
15013	8/6	G ^{1/2}	24	31	12	100
15014	10/8	G ^{1/8}	15	27,5	14	50
15015	10/8	G ^{1/4}	17	29,5	14	50
15016	10/8	G ^{3/8}	20	30,5	14	50
15017	10/8	G ^{1/2}	24	34	14	50
15018	12/10	G ^{3/8}	20	31,5	15	25
15019	12/10	G ^{1/2}	24	35	15	25
15021	12/9	G ^{1/4}	20	31,5	15	25
15023	12/9	G ^{3/8}	20	31,5	15	25
15020	15/12,5	G ^{1/2}	24	36,5	22	25

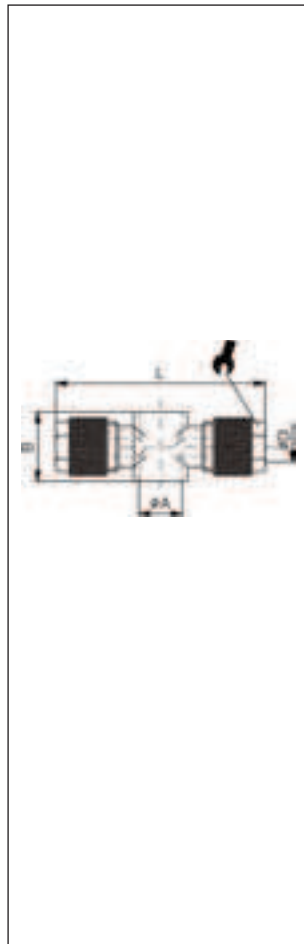

406

Ringstück 2-fach

Double banjo body

ITV	ØD	A	B	L		
15101	4/2,7	M5	12,5	39	8	100
15102	4/2,7	G ^{1/8}	15	46,5	8	100
15120	4,3/3	M5	9	33	8	100
15121	4,3/3	G ^{1/8}	15	46,5	8	100
15103	5/3	M5	9	33	8	100
15104	5/3	G ^{1/8}	15	46,5	8	100
15105	6/4	M5	9	33	9	100
15106	6/4	G ^{1/8}	15	46,5	10	100
15107	6/4	G ^{1/4}	17	50,5	10	100
15108	6/4	G ^{3/8}	20	53,5	10	100
15109	8/6	G ^{1/8}	15	50	12	100
15110	8/6	G ^{1/4}	17	55	12	100
15111	8/6	G ^{3/8}	20	55,5	12	100
15112	8/6	G ^{1/2}	24	62,5	12	100
15113	10/8	G ^{1/8}	15	55	14	50
15114	10/8	G ^{1/4}	17	59	14	50
15115	10/8	G ^{3/8}	20	61	14	50
15116	10/8	G ^{1/2}	24	68	14	50
15117	12/10	G ^{3/8}	20	63	15	25
15118	12/10	G ^{1/2}	24	70	15	25
15122	12/9	G ^{3/8}	14,5	66	15	25
15119	15/12,5	G ^{1/2}	24	62	22	25

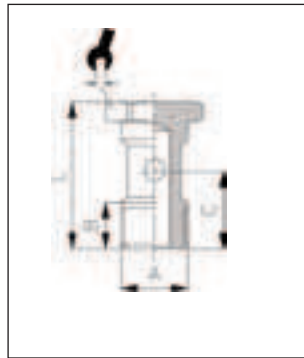

407

Hohlschraube 1-fach

Single screw

ITV	A	B	C	L		
14101	M5	5,8	9,6	17,5	8	100
14106	M6	7,5	10,8	19	8	100
14102	G ^{1/8}	8,5	15	28	14	50
14403	G ^{1/4}	12	18	33	17	50
14404	G ^{3/8}	13	21	36	19	50
14405	G ^{1/2}	15	23,5	42	24	25

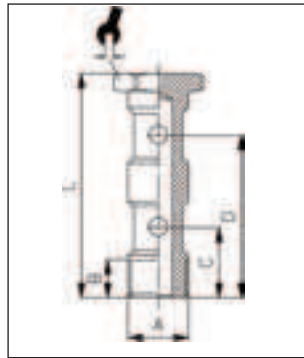

408

Hohlschraube 2-fach

Double screw

ITV	A	B	C	D	L		
14202	G ^{1/8}	9	15	31	44,5	14	50
14503	G ^{1/4}	11	17	36	51,5	17	50
14504	G ^{3/8}	14	20,5	43	58	19	50
14505	G ^{1/2}	15,5	23,5	49,5	68	24	25

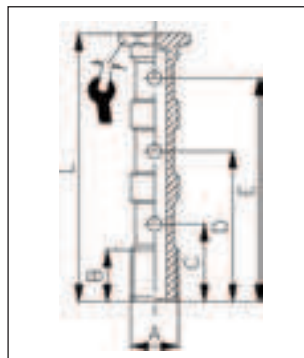

415

Hohlschraube 3-fach

Triple screw

ITV	A	B	C	D	E	L		
14301	G ^{1/8}	9	16	32,5	48	60	14	50
14703	G ^{1/4}	12	18,5	37	55,5	70,5	17	50
14303	G ^{3/8}	13	20	43	65	80	19	50
14705	G ^{1/2}	16	25	51	70,5	94	24	25

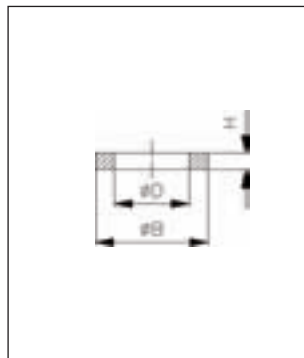
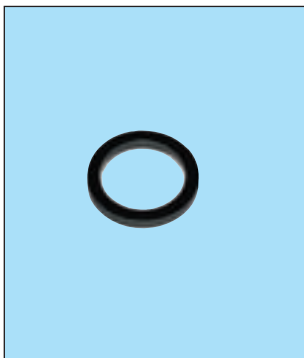

411

Dichtring PVC-hart schwarz | Sealing ring, black

ITV	ØD	ØB	H	für Gew.	
800031	5,3	7,7	1	M5	200
800032	10,2	13	1,5	G ^{1/8}	200
800033	13,4	17,9	2	G ^{1/4}	200
800034	17,1	21,8	2	G ^{3/8}	200
800035	21,3	26,5	2	G ^{1/2}	100
800036	26,7	32,4	2	G ^{3/4}	100
800037	33,5	39	2	G1	100

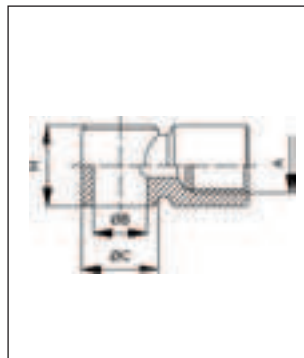

412

Ringstück mit Innengewinde

Female single banjo body

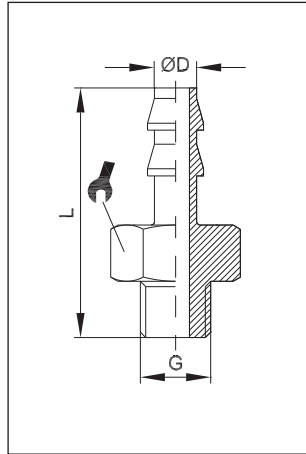

ITV	A	ØB	ØC	H	
60901	M5	5	-	10	100
60902	G ^{1/8}	10	14	15	50
60903	G ^{1/4}	13,5	18	17	50
60904	G ^{3/8}	17	21	20	25
60905	G ^{1/2}	21	26	24	25



601

Stecknippel-Einschraubverschraubung

Connector male threaded

ITV	ØD	G	L		
150001	3	M5	17	8	50
150002	4	M5	18	8	50

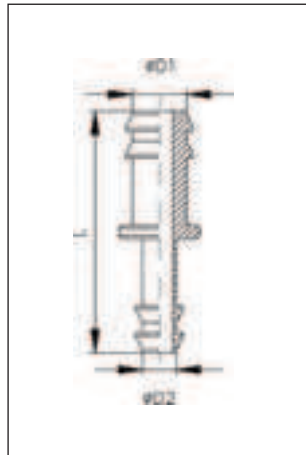

603

Stecknippel-Verbinder

Push-in connector

ITV	ØD1	ØD2	L	
150401	2	2	20	50
150402	3	2	20	50
150403	3	3	20	50
150404	4	3	21	50
150405	4	4	22	50
150406	6	4	22	50
150407	6	6	22	50

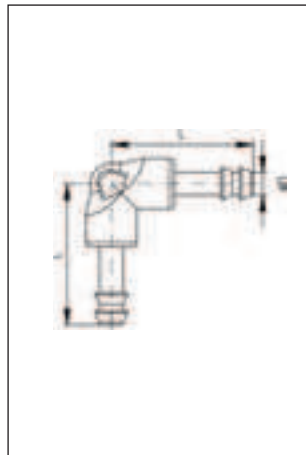

604

Stecknippel-Winkelverbinder

Push-in elbow connector

ITV	ØD	L	
151301	2	16	50
151302	3	16	50
151303	4	22	50
151304	6	22	50

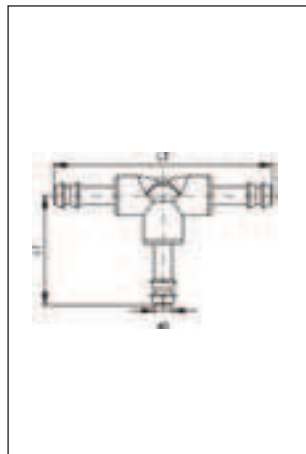

605

Stecknippel-T-Verbinder

T-Connector

ITV	ØD	L1	L2	
152301	2	16	32	50
152302	3	16	32	50
152303	4	22	44	50
152304	6	22	44	50